

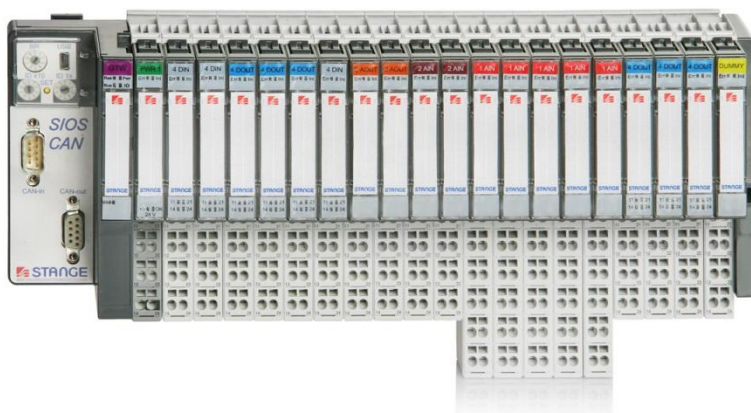

# Technical documentation SIOS I/O system Operating instructions



**Documentation: 2025-02-05**  
**Version: 20250205-EN**



These operating instructions have been prepared with due care.

 <b>Please note!</b>	<b>This documentation remains valid for newer firmware versions until a new version of the document is published.</b>
--	---

STANGE Elektronik GmbH accepts no liability for the factual accuracy of foreign-language terms and texts if it can be proven that a specialist translator who is not a member of the sales team was commissioned with the translation.

The contents of these operating instructions and the associated software products are the property of STANGE Elektronik and are protected by copyright. Reproduction - in whole or in part - is not permitted without the express permission of STANGE Elektronik.

**© STANGE Elektronik GmbH**  
Rudolf-Diesel-Str. 17-19  
51674 Wiehl  
Germany

Tel: +49 2261 9579-0  
Fax: +49 2261 55212

[www.stange-elektronik.com](http://www.stange-elektronik.com)  
[info@stange-elektronik.de](mailto:info@stange-elektronik.de)

**EC DECLARATION OF CONFORMITY**

We, the company



**Rudolf-Diesel-Str. 17-19**  
**51674 Wiehl**  
**Germany**

declare under our sole responsibility that the product

Designation: **SIOS**

Type: SIOS-CAN, SIOS-PWR, SIOS-PWRG, SIOS-IW1-XL, SIOS-IW2,  
SIOS-DI4, SIOS-DO4, SIOS -DAC2

with the requirements of the harmonized EU standards

**EN 61000-6-2 (interference immunity)**

EN 61000-4-2:2009  
EN 61000-4-3:2006 + A1, A2  
EN 61000-4-4:2004 + A1  
EN 61000-4-5:2006  
EN 61000-4-6:2009

**EN 55011, class A (emission)**

CISPR 11 Interference voltage / interference current  
CISPR 11 Radiation E-field

and thus complies with the provisions of the

**EMC Directive 2004/108/EC.**

Gummersbach, 16.10.2012

Place and date of the exhibition



P. Jaspert (Managing Director)

Name, legally binding signature



### **IMPORTANT FOR OPERATIONAL SAFETY!**

(Ensuring electromagnetic compatibility)

- The SIOS system may only be operated on 24V<sub>DC</sub> systems. 24V<sub>AC</sub> as supply voltage is **not** permitted!
- The SIOS system must always be mounted on earthed standard rails.
- All analog I/O cables must be shielded.
- The shielding must be continuous and should preferably be contacted with shield clamps near the SIOS standard rail on the reference ground (mounting wall).



**ATTENTION!**

**The shielding of the I/O cables must only be connected on one side, close to the SIOS unit. Cables with an insulated braided shield should always be used.**

## TABLE OF CONTENTS

<b>1</b>	<b>GENERAL INFORMATION.....</b>	<b>9</b>
1.1	INFORMATION OF OPERATING INSTRUCTIONS .....	9
1.2	EXPLANATION OF SYMBOLS .....	9
1.3	LIABILITY AND WARRANTY .....	10
1.4	INTENDED USE .....	11
1.5	TRANSPORTATION .....	12
1.6	REPAIRS .....	12
1.7	WASTE DISPOSAL .....	12
1.8	MANUFACTURER'S ADDRESS .....	12
1.9	TECHNICAL SUPPORT .....	12
<b>2</b>	<b>GENERAL DATA .....</b>	<b>13</b>
2.1	TECHNICAL DATA .....	13
2.2	SYSTEM CONCEPT .....	14
2.3	HARDWARE CONCEPT .....	15
2.4	GATEWAY VIEW .....	16
2.4.1	<i>CAN connection</i> .....	17
2.4.2	<i>Node ID rotary switch: Setting the bus address</i> .....	17
2.4.3	<i>Baud rate rotary switch</i> .....	19
<b>3</b>	<b>SIOS MODULES.....</b>	<b>21</b>
3.1	GENERAL INFORMATION.....	21
3.2	SIOS-CAN GATEWAY INTERFACE MODULE .....	22
3.2.1	<i>Performance features</i> .....	22
3.2.2	<i>LED information</i> .....	22
3.2.3	<i>CAN line PIN assignment</i> .....	24
3.2.3.1	CAN cable SE device↔ SIOS gateway (no. 1) .....	24
3.2.3.2	CAN line SIOS gateway (no. n)↔ SIOS gateway (no. n+1) .....	25
3.2.3.3	Terminating plug on the last SIOS gateway .....	25
3.3	SIOS-PWR (G) SUPPLY MODULE .....	26
3.3.1	<i>Performance features</i> .....	26
3.3.2	<i>LED information</i> .....	27
3.3.3	<i>Pin assignment</i> .....	28
3.4	SIOS-DI4 DIGITAL INPUT MODULE .....	29
3.4.1	<i>Performance features</i> .....	29
3.4.2	<i>LED information</i> .....	30
3.4.3	<i>Pin assignment</i> .....	31
3.5	SIOS-DO4 DIGITAL OUTPUT MODULE .....	32

3.5.1	<i>Performance features</i> .....	32
3.5.2	<i>LED information</i> .....	33
3.5.3	<i>Pin assignment</i> .....	34
3.6	SIOS- IW1 -XL ANALOG INPUT MODULE .....	35
3.6.1	<i>Performance features</i> .....	35
3.6.2	<i>LED information</i> .....	36
3.6.3	<i>Terminal assignment voltage, current, thermocouples</i> .....	38
3.6.3.1	Pin assignment PT100/PT1000 3-wire .....	39
3.6.3.2	Pin assignment PT100/PT1000 4-wire .....	40
3.6.3.3	Potentiometer pin assignment .....	41
3.7	SIOS-IW2 ANALOG INPUT MODULE .....	42
3.7.1	<i>Performance features</i> .....	42
3.7.2	<i>LED information</i> .....	43
3.7.3	<i>Pin assignment</i> .....	44
3.8	SIOS-DAC2 ANALOG OUTPUT MODULE.....	45
3.8.1	<i>Performance features</i> .....	45
3.8.2	<i>LED information</i> .....	46
3.8.3	<i>Pin assignment</i> .....	47
3.9	SIOS DUMMY RESERVE MODULE .....	48
3.9.1	<i>Performance features</i> .....	48
3.9.2	<i>LED information</i> .....	48
3.9.3	<i>Application example of a dummy module</i> .....	49
3.10	TERMINATING RESISTOR / TERMINATION PROTECTION MODULE .....	50
<b>4</b>	<b>PROJECT PLANNING</b> .....	<b>53</b>
4.1	GUIDELINES .....	53
4.2	DIMENSIONS.....	54
4.3	ADDRESSING .....	56
4.3.1	<i>Internal addressing of the SIOS modules</i> .....	56
4.3.2	<i>Global addressing</i> .....	56
<b>5</b>	<b>ASSEMBLY</b> .....	<b>57</b>
5.1	MOUNTING A SIOS NODE.....	57
5.2	SHIELD CONNECTION FOR ANALOG SIGNALS .....	61
5.3	REPLACEMENT OF MODULES .....	63
5.4	DISMANTLING THE MODULES .....	65
5.5	THE STRUCTURE OF THE MODULE .....	67
5.6	SAVE MODULE LIST (SET BUTTON) .....	69
<b>6</b>	<b>INDEX</b> .....	<b>71</b>
<b>7</b>	<b>DIRECTORIES</b> .....	<b>73</b>





# 1 General information

---

## 1.1 Information of operating instructions

---

These operating instructions are intended to enable the user to install, commission, operate and maintain the appliance correctly.

Before starting installation work, read and understand the operating instructions in full, especially the chapter on safety! Always comply with the operating instructions, in particular the safety instructions and the accident prevention regulations applicable to the area of use.

Always pass the device on to third parties together with the operating instructions.

## 1.2 Explanation of symbols

---

Important safety instructions in these operating instructions are marked with symbols. Always follow the instructions to avoid accidents, personal injury and damage to property.



**DANGER!**

This symbol indicates dangers that can lead to health hazards, injuries, permanent physical damage or death as well as considerable material damage.

It is imperative that you strictly adhere to the instructions on occupational safety and exercise particular caution in these cases.



**ATTENTION!**

This symbol indicates instructions which, if ignored, may result in damage, malfunction and/or failure of the appliance.



**Please note!**

This symbol highlights tips and information that must be observed for efficient and trouble-free operation of the appliance.

### 1.3 Liability and warranty

---

All information and instructions in these operating instructions have been compiled taking into account the applicable regulations, the current state of engineering development and our many years of knowledge and experience.

The translations of the operating instructions have also been prepared to the best of our knowledge. However, we cannot accept any liability for translation errors. The German version of these operating instructions provided is authoritative.

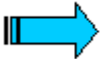
 <p><b>Please note!</b></p>	<p><b>These operating instructions must be read carefully before starting any work on and with the appliance, especially before commissioning! The manufacturer accepts no liability for damage and malfunctions resulting from non-compliance with the operating instructions.</b></p>
--	---

The operating instructions must be kept directly on the device and accessible to all persons working on or with the device. The transfer of the operating instructions to third parties is not permitted and may result in compensation for damages. Further claims reserved.

We reserve the right to make technical changes to the device in order to improve its performance characteristics and for further development.

## 1.4 Intended use

---

Proper transportation, storage, installation and assembly as well as careful operation and maintenance are required for the faultless and safe operation of the appliances.



**DANGER!**

**The devices described in this manual may only be used for the applications specified in this manual and only in conjunction with certified third-party devices and components. The operator alone is liable for any damage resulting from improper use.**

## 1.5 Transportation

---

Only use the original packaging to transport the device.

## 1.6 Repairs

---

Repairs may only be carried out by STANGE Elektronik GmbH. In this case, please contact the technical support of STANGE Elektronik GmbH.

No liability is accepted for any modifications to the device that are not described in this document.

## 1.7 Waste disposal

---

STANGE Elektronik GmbH will dispose of old appliances of the type SIOS in an environmentally friendly manner. We will dispose of all devices of this type if they are delivered free to the manufacturer's address stated above. Alternatively, please contact a certified disposal company for electronic waste.

## 1.8 Manufacturer's address

---

**Manufacturer:** **STANGE Elektronik GmbH**

Rudolf-Diesel-Str. 17-19

51674 Wiehl

Germany

**Phone:** **+49 (0)2261 - 95790**

**Fax :** **+49 (0)2261 - 55212**

**E-mail:** [info@stange-elektronik.de](mailto:info@stange-elektronik.de)

**Homepage:** [www.stange-elektronik.com](http://www.stange-elektronik.com)

## 1.9 Technical support

---

**Support:** **Phone:** **+49 (0)2261 - 957939**

**Fax:** **+49 (0)2261 - 55212**

**E-mail:** [support@stange-elektronik.de](mailto:support@stange-elektronik.de)

## 2 GENERAL DATA

### 2.1 Technical data

Table 1; Technical data

<b>Supply voltage:</b>	
Power module:	24 VDC (+/-15%)
DO4 / DI4 module:	24 VDC (+/-25%)
<b>Power consumption</b>	
Power module:	22 W (max.) / depending on the number of modules
	2 W for power module and gateway
	1 W per digital module
	2 W per analog module
DO4:	max. 68 W (4 x 0.7 A x 24 V) (depending on the connected loads)
<b>Temperature range</b>	
Operation:	0 ... 50°C
Storage:	-25 ... 80°C
<b>Space requirement / dimensions</b>	
Gateway:	74.0 x 115.0 x 51.0 mm (HxDxW)
Connection carrier (4AN):	74.0 x 129.0 x 12.7 mm (HxDxW)
Connection carrier (6AN):	74.0 x 154.0 x 12.7 mm (HxDxW)
Space requirement:	min. 20 mm all round
<b>Connection technology :</b>	
Connection type:	Tension spring connection
Stripping length:	8 mm
Clampable ladder:	0.5 to 1.5 mm <sup>2</sup>
Protection class	IP20

## 2.2 System concept

---

SIOS (Stange Input Output System) is a decentralized peripheral system that was designed for the process controllers of the 6th and 7th generation and can be flexibly adapted to the respective automation task thanks to its compact and finely modular design. The convenient connection technology of SIOS significantly reduces the wiring effort. If required, the SIOS peripheral units can also be easily expanded in the future and adapted to new conditions. A combination of SIOS and the predecessor system CAN-BASIS4 in a common CAN network is also possible when using SE-6xx and SE-7xx devices and taking into account the permissible quantity structure. SE-5xx devices can only be operated in a CAN network with CAN-BASIS4.

A SIOS peripheral unit consists of at least one gateway, one power module and one digital or analog I/O module. Up to 15 SIOS peripheral units can be integrated in a CAN bus system. A peripheral unit can in turn consist of up to 64 modules. The individual modules are hot-pluggable and can therefore be replaced during operation in the event of a fault.

## 2.3 Hardware concept

A SIOS peripheral unit (SIOS node) consists of several individual components that are snapped onto a top-hat rail (35 x 15 x 7.5 mm). The first unit of a SIOS node is always the SIOS- CAN gateway, which establishes communication between the SIOS master (SE-6xx / SE-702/7) and the I/O modules of the SIOS node. The gateway is followed by up to 64 modules (power or I/O modules). The individual module units each consist of a module carrier with a terminal connection block using spring-cage technology and a coded module slot, as well as the actual function module.

The PWRG power module must always be plugged in as the first module after the gateway. The special module carrier of the PWRG supplies both the gateway and the first 16 subsequent modules with power. If more than 16 I/O modules are to be used, another PWR power module must first be plugged in to supply power to the subsequent modules. The different module types have a color code that matches the coding plug of the module and the mating plug in the module slot of the module rack. This ensures that the different modules can only be plugged into the corresponding module carrier. The order of the individual modules after the first PWRG power module is arbitrary.

Table 2; List of the different module types

Module type	Description
<b>SIOS-CAN</b>	SIOS interface module for up to 64 SIOS I/O modules incl. power module for gateway supply and up to 16 I/O modules
<b>SIOS-PWR</b>	Power module incl. connection module (supply for up to 16 I/O modules)
<b>SIOS-DI4</b>	4 digital inputs incl. connection module
<b>SIOS-DO4</b>	4 digital outputs incl. connection module
<b>SIOS-IW1-XL</b>	1 Universal actual value input incl. connection module
<b>SIOS-IW2</b>	2 Standard signal actual value inputs incl. connection module
<b>SIOS-DAC2</b>	2 analog outputs incl. connection module

## 2.4 Gateway view

---

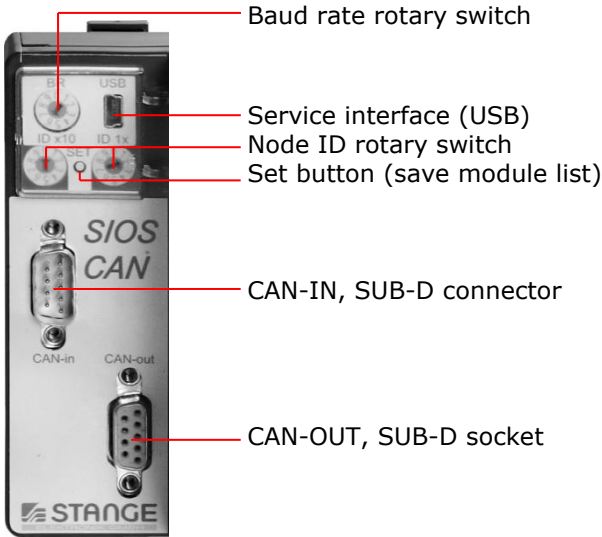

Figure 1; Gateway



### 2.4.1 CAN connection

Table 3; Gateway CAN connection

Pin no.	Signal	Description
1		
2	CAN LOW	Negative data signal
3		
4		
5		
6		
7	CAN HIGH	Positive data signal
8		
9		
Shield	Shield	Cable shield

Plug (male)	Socket (female)
 <p>9pin SubD</p>	 <p>9pin SubD</p>

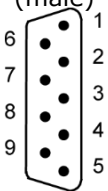
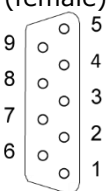
The use of the terminating plug is necessary for secure communication on the CAN bus (see)3.2.3.3

### 2.4.2 Node ID rotary switch: Setting the bus address

A bus address must be assigned to each SIOS gateway. For this purpose, there are two Node ID rotary switches, which are used to set the address (see chapter:2.4 ). This node ID must be identical to the bus address set in the device and may only exist once in the CAN network.



### 2.4.3 Baud rate rotary switch

The baud rate rotary switch is located on the gateway. The transmission speed can be set here via the bus.



Please note!

The baud rate is only queried during start-up (after connecting the power supply). This means that the gateway must be restarted to change the baud rate (disconnect and reconnect the power supply).



Figure 2; Baud rate rotary switch

Table 4; Baud rate settings

<b>Rotary switch</b>	<b>Baud rate</b>	<b>For a maximum bus length of up to</b>
<b>0</b>	20 kB	2,500 m → 20 kBaud
<b>1</b>	50 kB	1,000 m → 50 kBaud
<b>2</b>	100 kB	750 m → 100 kBaud
<b>3</b>	125 kB	500 m → 125 kBaud
<b>4</b>	250 kB	250 m → 250 kBaud
<b>5</b>	500 kB	100 m → 500 kBaud
<b>6</b>	1000 kB	25 m → 1 MBaud

 <b>Please note!</b>	<b>In a CANopen network, the same transmission rate must be set for all participants.</b>
--	---

## 3 SIOS modules

---

### 3.1 General information

---

The individual SIOS modules are hot-pluggable and can also be replaced during operation in the event of a fault.

If there are several unoccupied slots and a module is first plugged into a rear free slot, this module is not initialized until all front free slots are occupied.



## 3.2 SIOS-CAN Gateway interface module

SIOS-CAN enables the operation of SIOS modules on CANopen. The entire process data traffic between the I/O level and the fieldbus is handled and the required diagnostic data is generated.

### 3.2.1 Performance features

- Can be flexibly equipped with up to 64 modules
- CANopen protocol
- Baud rates: 20 kB, 50kB, 100kB, 125kB, 250kB, 500kB, 1MBaud
- CAN connection, galvanically isolated
- LED status for CAN communication, IO bus communication and power supply
- Incl. power module SIOS- PWRG
- Housing: 74.0 x 115.0 x 51.0mm (HxDxW)



Figure 3; SIOS-CAN Gateway

### 3.2.2 LED information

Table 5; LED information

LED	Color	Condition	Description
<b>Res</b>	Red	Permanent lights	The gateway is reset → Check power supply; replace PWR module next to the gateway if necessary
<b>Pwr</b>	Green	Permanent lights	Gateway is supplied with power → Everything ok; no measures necessary
<b>Bus</b>	Yellow	1 Hz Flashing	No communication via the CAN bus → Check the following: Connection/cable, address, baud rate, CAN termination plug
<b>Bus</b>	Yellow	2 Hz Flashing	Gateway is configured via CAN

<b>Bus</b>	Yellow	Permanent lights	<p>→ Wait until Configuration completed          CAN bus initialized and gateway ready for operation</p> <p>→ Everything ok; no action required</p>
<b>IO</b>	Yellow	From	Internal module bus ok
<b>IO</b>	Yellow	1 Hz Flashing	<p>Error on the internal module bus</p> <p>→ A module is faulty or has an error message, e.g. actual value break etc. Errors are usually displayed on the affected module.</p> <p>→ Target list not equal to actual list (internal module list of the gateway); if necessary, a new target list must be saved using the SET button</p> <p>→ Check the terminating resistor of the modules</p>
<b>USB</b>	Yellow	From	No USB connected
<b>USB</b>	Yellow	Permanent lights	<p>USB connected</p> <p>→ USB communication only works if the CAN bus has been disconnected.</p>
<b>Err</b>	Red	From	Power supply ok
<b>Err</b>	Red	1 Hz Flashing	<p>Power module must supply more than 16 modules</p> <p>→ Add a power module after every 16th module</p>
<b>Err</b>	Red	2 Hz Flashing	<p>Power module must supply more than 17 modules</p> <p>→ Add a power module after every 16th module</p>

### 3.2.3 CAN line PIN assignment

The cables must be twisted in pairs and shielded. The shielding is connected to **one side of** the device via the connector housing.

#### 3.2.3.1 CAN cable SE device ↔ SIOS gateway (no. 1)

Connection  
SE-XXX  
9-pin DSub socket (female)

CAN-In" connection  
SIOS gateway  
9-pin DSub socket (female)

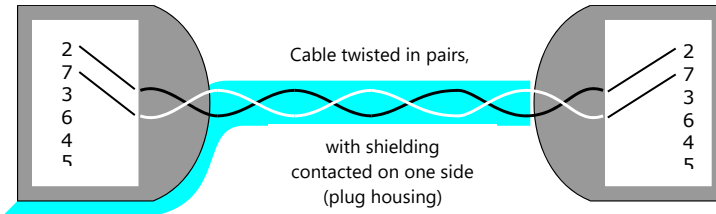

2 = low / 7 = high

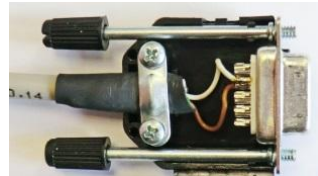

Figure 4; CAN cable SE device -<=> SIOS gateway



### 3.2.3.2 CAN line SIOS gateway (no. n) ↔ SIOS gateway (no. n+1)

CAN-Out" connection  
 SIOS gateway (no. n)  
 9-pin DSub connector (male)

CAN-In" connection  
 SIOS gateway (No. # +1)  
 9-pin DSub socket (female)

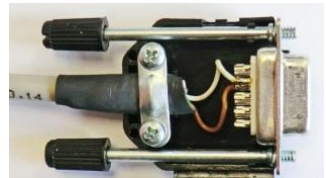
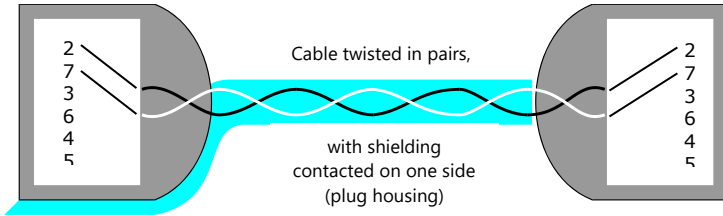
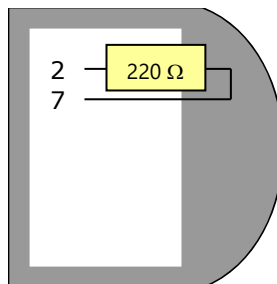

Figure 5; CAN cable SIOS - <> SIOS

### 3.2.3.3 Terminating plug on the last SIOS gateway

The use of the terminating plug is necessary for secure communication on the CAN bus:



CAN-Out" connection  
 of the last SIOS-CAN  
 gateway  
 9-pin DSub connector

Figure 6; Terminating plug PIN assignment

### 3.3 SIOS-PWR (G) Supply module

---

The power modules are used to supply the various modules with the connection voltage.

#### 3.3.1 Performance features

---

Supplies the modules internally with power

- Input voltage: 24 V DC
- Supply of max. 16 modules incl. power module
- Module variants:
  - SIOS-PWRG (supplies the gateway and the first 16 modules)
  - SIOS-PWR (supplies a further 16 modules incl. power module)
- Dimensions with module carrier: 74.0 x 129.0 x 12.7 mm (HxDxW)



Figure 7; SIOS module

### 3.3.2 LED information

---

Table 6; PWR module LED messages

LED	Color	Condition	Description
<b>Ini</b>	Green	From	No power supply
<b>Ini</b>	Green	1 Hz Flashing	Not initialized, Daisy chain is not connected → the chain of modules, CAN connection and gateway → Check the configuration of the CAN hardware → If necessary, save the module list using the Set button
<b>Ini</b>	Green	2 Hz Flashing	Not initialized, daisy chain is on → Check CAN connection and gateway → Check the configuration of the CAN hardware → If necessary, save module list using the Set button
<b>Ini</b>	Green	Permanent lights	Module was recognized
<b>Err</b>	Red	From	No error
<b>Err</b>	Red	2 Hz Flashing	Module not tested → The module has lost its calibration, return to the manufacturer
<b>+/-</b>	Red	Permanent lights	Wiring error → 24V reverse polarity, correct
<b>Ok</b>	Green	Permanent lights	24V voltage is applied externally

### 3.3.3 Pin assignment

---

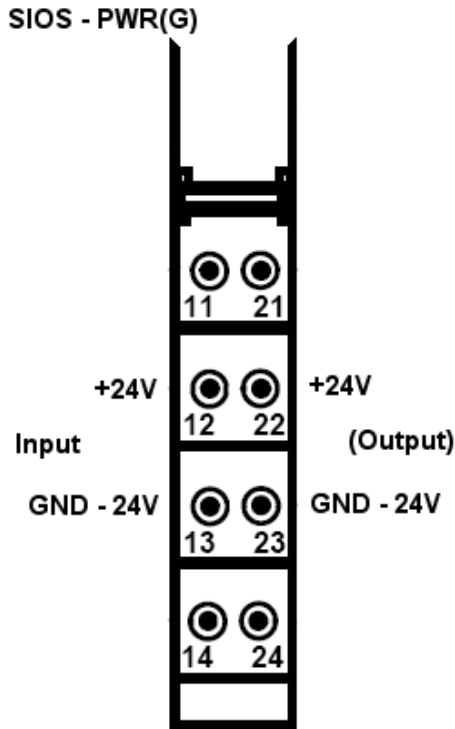

Figure 8; PWR module pin assignment

## 3.4 SIOS-DI4 digital input module

---

Digital input modules record electrical high and low levels via the connections of the base module. The corresponding digital value is transmitted to the gateway via the internal module bus.

### 3.4.1 Performance features

---

- Digital inputs
- Galvanic isolation from the internal bus (max. 500V, no isolation between the inputs)
- Input voltage: 15 ... 24 V for active level
- Input current at active level: approx. 3 mA
- Dimension with module carrier:  
74.0 x 129.0 x 12.7 mm (HxDxW)



### 3.4.2 LED information

Table 7; LED messages DI4 module

LED	Color	Condition	Description
<b>Ini</b>	Green	From	No power supply
<b>Ini</b>	Green	1 Hz Flashing	Not initialized, Daisy chain is not connected → the chain of modules, CAN connection and gateway → Check the configuration of the CAN hardware → If necessary, save the module list using the Set button
<b>Ini</b>	Green	2 Hz Flashing	Not initialized, daisy chain is on → Check CAN connection and gateway → Check the configuration of the CAN hardware → If necessary, save module list using the Set button
<b>Ini</b>	Green	Permanent lights	Module was recognized
<b>Err</b>	Red	From	No error
<b>Err</b>	Red	2 Hz Flashing	Module not tested → Back to the manufacturer
<b>Err</b>	Red	Permanent lights	An entrance bounces → Check input signal
<b>11, 12, 14, 24</b>	Yellow	From	Digital input not set
<b>11, 12, 14, 24</b>	Yellow	Permanent lights	Digital input set

### 3.4.3 Pin assignment

---

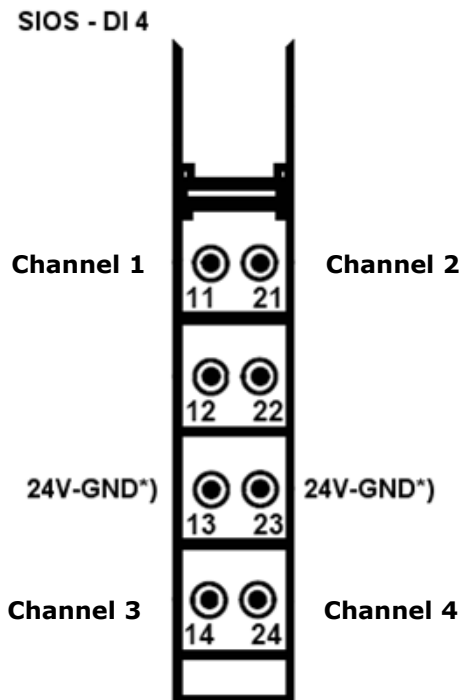

**\*) connection not mandatory**

Figure 9; DI4 module pin assignment

If the input voltages for the SIOS DI4 module have the same reference as the SIOS supply voltage, the "24V-GND" connection can remain unconnected. However, if the input voltages have no reference to the SIOS supply system (e.g. with a separate power supply unit), this reference can be established via the "24V-GND" connection.

## 3.5 SIOS-D04 digital output module

---

Digital output modules receive output values from the gateway via the internal module bus. Corresponding low or high levels are converted via the modules and output to the field level channel by channel via the base module.

### 3.5.1 Performance features

---

- Digital outputs
- Galvanic isolation from the internal bus (max. 500 V, no isolation between the outputs)
- Supply voltage outputs: 7 ... 24 V
- Output current: max. 700 mA per output
- Freewheeling diode per output
- Residual current in off-state: max. 3  $\mu$ A
- Outputs short-circuit proof
- Dimension with module carrier: 74.0 x 129.0 x 12.7 mm (HxDxW)

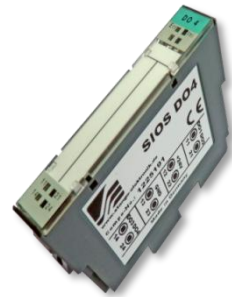



### 3.5.2 LED information

Table 8; LED messages DO4 module

LED	Color	Condition	Description
<b>Ini</b>	Green	From	No power supply
<b>Ini</b>	Green	1 Hz Flashing	Not initialized, daisy chain is not connected → the chain of modules, CAN connection and gateway → Check the configuration of the CAN hardware → If necessary, save the module list using the Set button
<b>Ini</b>	Green	2 Hz Flashing	Not initialized, daisy chain is on → Check CAN connection and gateway → Check the configuration of the CAN hardware → If necessary, save module list using the Set button
<b>Ini</b>	Green	Permanent lights	Module was recognized
<b>Err</b>	Red	From	No error
<b>Err</b>	Red	2 Hz Flashing	Module not tested → Back to the manufacturer
<b>11, 12, 14, 24</b>	Yellow	From	Digital output not set
<b>11, 12, 14, 24</b>	Yellow	Permanent lights	Digital output set

### 3.5.3 Pin assignment

---

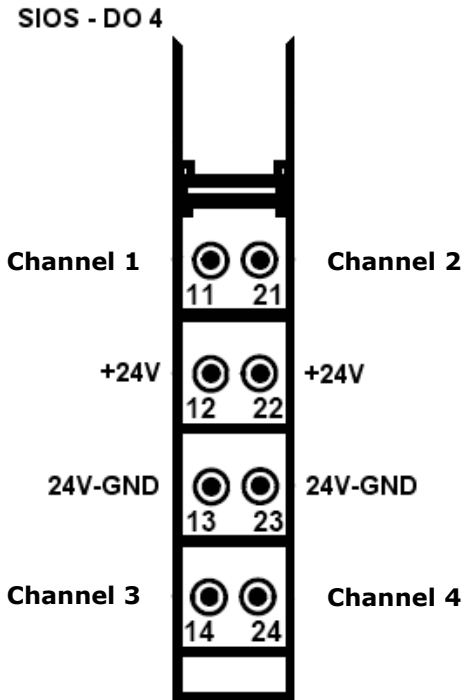

**+24V / 24V-GND each bridged internally**

Figure 10; DO4 module pin assignment

## 3.6 SIOS- IW1 -XL analog input module

---

Analogue input modules record standardized electrical signals via the connections of the base module. These are digitized and the corresponding measured value is transmitted to the gateway via the internal module bus.

### 3.6.1 Performance features

---

- 1 universal analog input
- Galvanic isolation from the internal bus (max. 500 V)
- 0-10 V, 0-20 mA, 4-20 mA, thermocouples, PT100, PT1000, potentiometer (<4 k $\Omega$ )
- 18 bit resolution
- Accuracy: better than 0.1% of end of range
- Measuring cycle per thermocouple approx. 60 ms
- Measuring cycle per PT element 100 ms
- A reference measurement every 60 seconds
- Measurement of the terminal point temperature every 10 seconds
- Dimensions with module carrier: 74.0 x 154.0 x 12.7 mm (HxDxW)
- The module rack has an internal PT1000 sensor for recording the terminal point temperature
- Input resistance voltage measurement: approx. 1 M $\Omega$  <sup>1</sup>
- Load current measurement: 50  $\Omega$

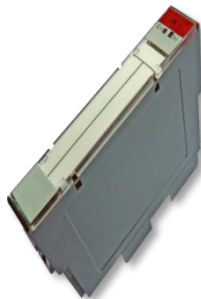

---

<sup>1</sup> depending on the internal measurement path, which is determined by the configured measurement type.

### 3.6.2 LED information

Table 9; LED messages IW1-XL module

LED	Color	Condition	Description
<b>Ini</b>	Green	From	No power supply
<b>Ini</b>	Green	1 Hz Flashing	Not initialized, Daisy chain is not connected → the chain of modules, CAN connection and gateway → Check the configuration of the CAN hardware → If necessary, save the module list using the Set button
<b>Ini</b>	Green	2 Hz Flashing	Not initialized, daisy chain is on → Check CAN connection and gateway → Check the configuration of the CAN hardware → If necessary, save module list using the Set button
<b>Ini</b>	Green	Permanent lights	Module was recognized
<b>Err</b>	Red	From	No error
<b>Err</b>	Red	1 Hz Flashing	Module not calibrated → Back to the manufacturer
<b>Err</b>	Red	2 Hz Flashing	Actual value: Break, overflow, underflow → Check input signal
<b>Err</b>	Red	50 Hz Flashing	Initialization of the measuring electronics → Normal behavior during module initialization after start-up or after a new actual value configuration has been accepted → Should take care of itself after a few seconds → Otherwise check the shielding of the measuring cable (connect on one side of the module)
<b>Err</b>	Red	Permanent lights	No measurement type has been defined → Check actual value configuration



### 3.6.3 Terminal assignment voltage, current, thermocouples

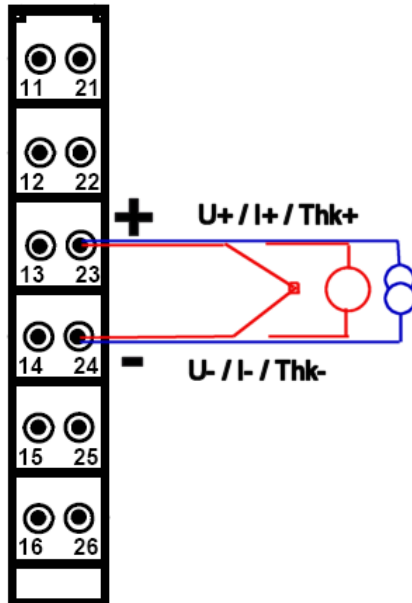

Figure 11; IW1-XL module connection assignment

The positive pole of the measurement is connected to terminal 23 and the negative pole of the measurement to terminal 24.

This applies to thermocouple, current and voltage measurement.

The current measurement **does not** require an external 50 Ω resistor or a bridge.

Table 10; IW1 module Error ranges

Measurement	Range	Overflow	Underflow	Breakage
<b>Voltage</b>	0-10 V	10,475 V	-0,25 V	--
<b>Voltage</b>	0-2.56 V <sup>2</sup>	>2,56 V	-0,25 V	--
<b>Electricity</b>	0-20 mA	20.95 mA	-0.5 mA	--
<b>Electricity</b>	4-20 mA	20.95 mA	3.6 mA	2.0 mA

<sup>2</sup> Only for SE-702/707 from device software vers. 7.1.2.0 when using the "oxygen probe" measurement type (linear measurement), scaling to 0...100%; linear code 0x01 for SE-6xx/CODESYS

### 3.6.3.1 Pin assignment PT100/PT1000 3-wire

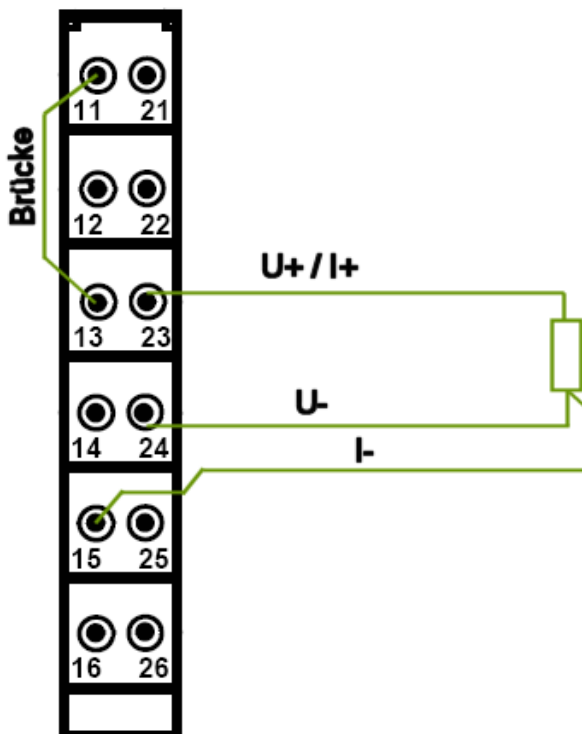

Figure 12; IW1-XL module Terminal assignment PT 3-wire

For 3-wire measurement, a jumper must be connected between terminals 11 and 13. The positive measurement path is connected to terminal 23. The negative measurement path is connected to terminals 24 and 15.

3.6.3.2 Pin assignment PT100/PT1000 4-wire

---

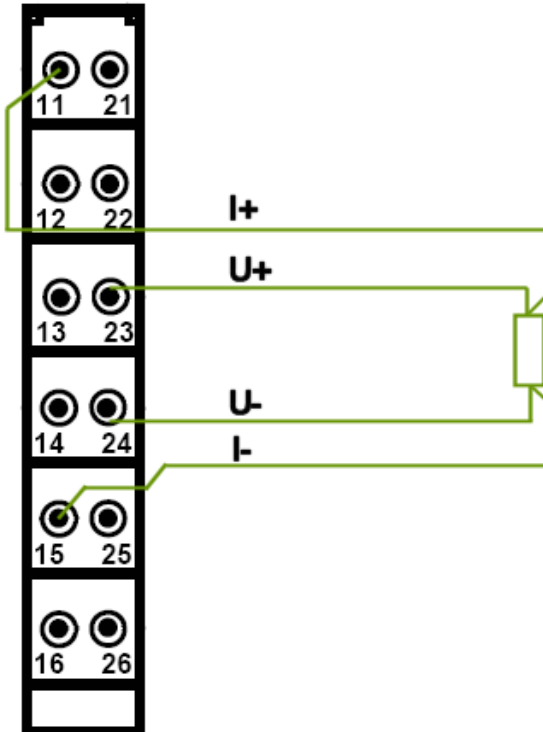

Figure 13; IW1-XL module Pin assignment PT 4-wire

For 4-wire measurement, the positive measurement path is connected to terminals 11 and 23 and the negative measurement path to terminals 24 and 15.



### 3.6.3.3 Potentiometer pin assignment

---

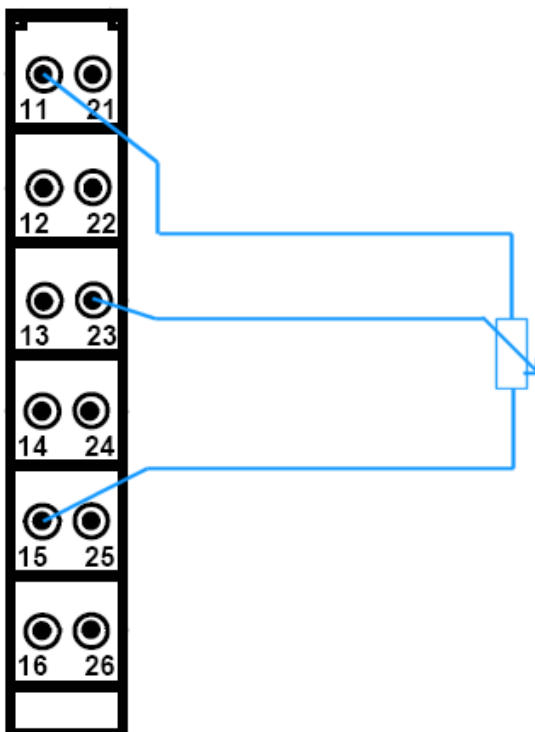

Figure 14; IW1-XL module Potentiometer connection assignment

The two ends of the potentiometer are connected to terminals 11 and 15. The middle contact (wiper) is connected to terminal 23.

## 3.7 SIOS-IW2 analog input module

---

Analogue input modules record standardized electrical signals via the connections of the base module. These are digitized and the corresponding measured value is transmitted to the gateway via the internal module bus.

### 3.7.1 Performance features

---

- 2 Analog inputs (standard signal) 0-10 V, 0-20 mA, 4-20 mA
- Accuracy: better than 0.1% of end of range
- Measuring cycle per input approx. 40 ms
- 18-bit resolution
- Galvanic isolation from the internal bus (max. 500 V, no isolation between the inputs)
- Dimension with module carrier: 74.0 x 129.0 x 12.7 mm (HxDxW)
- Input resistance voltage measurement: approx. 1 MOhm<sup>3</sup>
- Load current measurement: 50 Ohm



---

<sup>3</sup> Measurement errors must be expected with high-impedance signal sources (e.g. O2 probes).

In these cases, it is recommended that an impedance transformer be installed.

---

### 3.7.2 LED information

Table 11; LED messages IW2 module

LED	Color	Condition	Description
<b>Ini</b>	Green	From	No power supply
<b>Ini</b>	Green	1 Hz Flashing	Not initialized, Daisy chain is not connected → the chain of modules, CAN connection and gateway → Check the configuration of the CAN hardware → If necessary, save the module list using the Set button
<b>Ini</b>	Green	2 Hz Flashing	Not initialized, daisy chain is on → Check CAN connection and gateway → Check the configuration of the CAN hardware → If necessary, save module list using the Set button
<b>Ini</b>	Green	Permanent lights	Module was recognized
<b>Err</b>	Red	From	No error
<b>Err</b>	Red	1 Hz Flashing	Module not calibrated → Back to the manufacturer
<b>Err</b>	Red	2 Hz Flashing	Actual value break, overflow, underflow → Check input signal
<b>Err</b>	Red	Asynchronous Flashing	Initialization of the measuring electronics → Should take care of itself, otherwise return to the manufacturer
<b>Err</b>	Red	Permanent lights	No measurement type has been defined → Check actual value configuration

### 3.7.3 Pin assignment

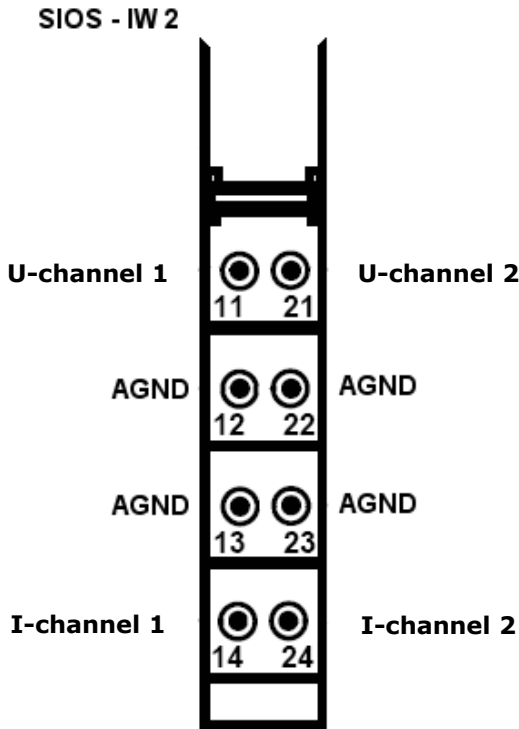

Figure 15; Pin assignment IW2- module

Table 12; IW-2 module error areas

Measurement	Range	Overflow	Underflow	Breakage
<b>Voltage</b>	0-10 V	10,1 V	-1,0 V	--
<b>Electricity</b>	0-20 mA	20.2 mA	-1.0 mA	--
<b>Electricity</b>	4-20 mA	20.2 mA	3.5 mA	2.0 mA

## 3.8 SIOS-DAC2 analog output module

Analog output modules receive output values from the gateway via the internal module bus. Corresponding signals are converted and output to the field level on a channel-by-channel basis via the base module.

### 3.8.1 Performance features

- 2 analog outputs
- Configurable as 0-10 V, 0-20 mA or 4-20 mA
- 12-bit resolution
- Galvanic isolation from the internal bus (max. 500V, no isolation between the outputs)
- Output accuracy: better than 0.1% of end of range
- Current output: max. load 500 Ohm
- Voltage output: min. load 2 kOhm
- Dimension with module carrier:  
74.0 x 129.0 x 12.7 mm (HxDxW)



**ATTENTION!**

**Only the range type that has been configured is output correctly. If the 0-10V type is selected for channel 1, a non-calibrated value is output for the channel's current path. The same applies in the opposite case. If current is to be output, the voltage is not calibrated.**

### 3.8.2 LED information

Table 13; LED messages DAC2 module

LED	Color	Condition	Description
<b>Ini</b>	Green	From	No power supply
<b>Ini</b>	Green	1 Hz Flashing	Not initialized, Daisy chain is not connected → the chain of modules, CAN connection and gateway → Check the configuration of the CAN hardware → If necessary, save the module list using the Set button
<b>Ini</b>	Green	2 Hz Flashing	Not initialized, daisy chain is on → Check CAN connection and gateway → Check the configuration of the CAN hardware → If necessary, save module list using the Set button
<b>Ini</b>	Green	Permanent lights	Module was recognized
<b>Err</b>	Red	From	No error
<b>Err</b>	Red	1 Hz Flashing	Module not calibrated → Back to the manufacturer
<b>Err</b>	Red	Permanent lights	No output type has been defined → Check configuration

### 3.8.3 Pin assignment

---

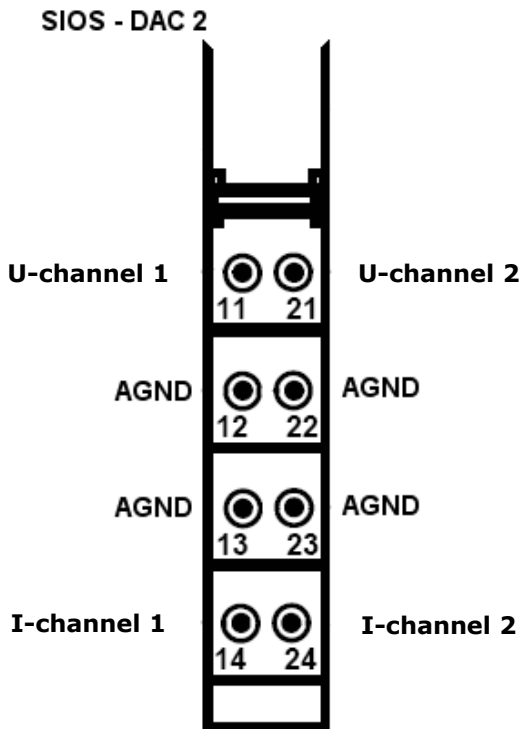

Figure 16; DAC2 module connection assignment

## 3.9 SIOS Dummy Reserve module

The dummy module is used to simulate a programmed target module or as a placeholder for expansion purposes.

### 3.9.1 Performance features

- No inputs or outputs
- Simulates the programmed target module
- Can be plugged into any module slot
- Dimension with module carrier:  
74.0 x 129.0 x 12.7 mm or  
74.0 x 154.0 x 12.7 mm (HxDxW)

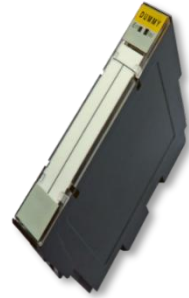

### 3.9.2 LED information

Table 14; LED messages dummy module

LED	Color	Condition	Description
<b>Ini</b>	Green	From	No power supply
<b>Ini</b>	Green	1 Hz Flashing	Not initialized, Daisy chain is not connected → the chain of modules, CAN connection and gateway → Check the configuration of the CAN hardware → If necessary, save the module list using the Set button
<b>Ini</b>	Green	2 Hz Flashing	Not initialized, daisy chain is on → Check CAN connection and gateway → Check the configuration of the CAN hardware → If necessary, save module list using the Set button
<b>Ini</b>	Green	Permanent lights	Module was recognized



### 3.9.3 Application example of a dummy module

---

A system manufacturer only wants to use a SIOS configuration in which all possible system options are already preconfigured. The I/Os of the system options that are not required are initially replaced by cheaper dummy modules. If the customer subsequently orders a system option, then only the dummy modules need to be replaced by the corresponding pre-configured I/O modules.

Even if the system manufacturer wants to sort the I/O cards (e.g. first the digital inputs I/Os and then the analog I/Os) and does not want to attach new I/O modules to the end of the SIOS node if necessary, it makes sense to use dummy modules as placeholders for reserve purposes.

No dummy module is required for the exVoltage at the end of the node.

### **3.10 Terminating resistor / Termination protection module**

---

For successful bus communication on the IO backplane bus, a 110 Ohm terminating resistor must be plugged in behind the last module!

The terminating resistor is plugged into the communication bus connector on the last module. The terminating protection module can be plugged in without interference.



**ATTENTION!**

**Without this terminating resistor, extreme bus interference can occur with any number of modules and successful communication between the gateway and the modules is not guaranteed!**

**When installing, make sure that the resistor points upwards (towards the modules)!**

Terminating resistor:

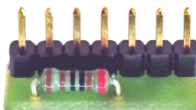

Plugged in:

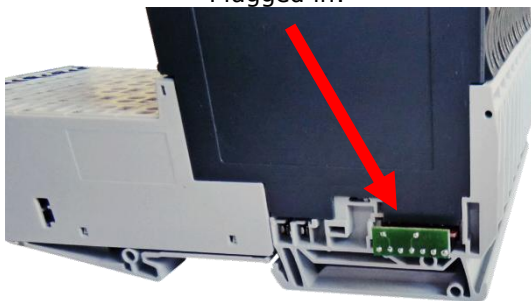

Terminating protection module plugged in:

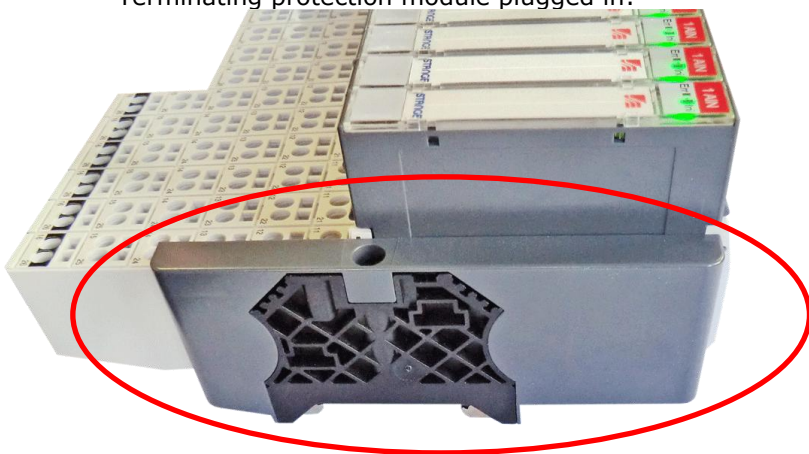



## 4 Project planning

---

### 4.1 Guidelines

---

The following guidelines must be observed when configuring SIOS:

- A maximum of 15 CAN gateways can be operated in a CAN network.
- A CAN gateway can be equipped with a maximum of 64 modules (including power modules).
- The PWRG power module must be plugged in as the first module after the gateway.
- After 10 I/O modules, a PWR power module must be plugged in again.
- The modules must be plugged together without gaps. Free module slots are not permitted. If module racks are to be wired for reserve reasons, the free module slots must be fitted with SIOS dummy modules.
- The theoretical number of 6336 modules (99 gateways with 64 modules each) is reduced by the limits of the CANopen protocol. The CAN bus can use a maximum of 512 process data telegrams (PDO telegrams) per data direction. There are 8 bytes of user data available in each PDO. If, for example, only analog input modules were used, a maximum of 1024 analog values could be used in the entire CAN network.

The number of SIOS gateways that can be used has therefore been limited to 15.

## 4.2 Dimensions

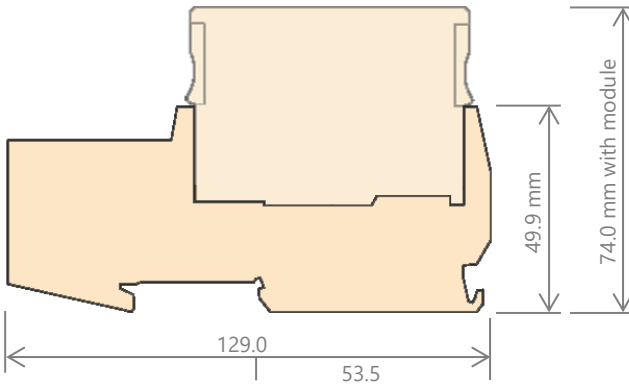

Figure 17; SIOS connection module

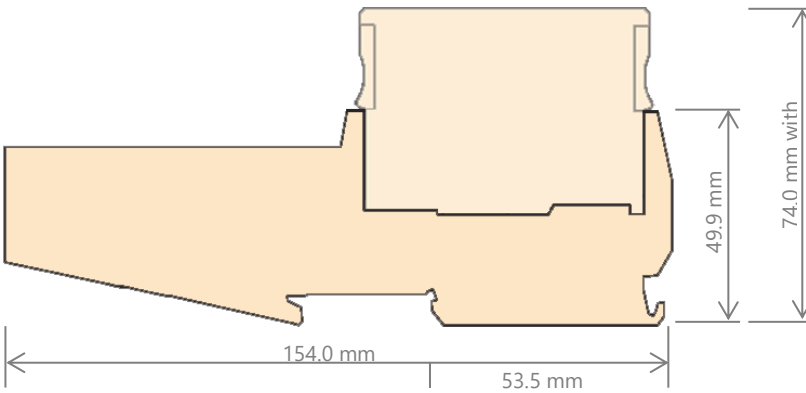
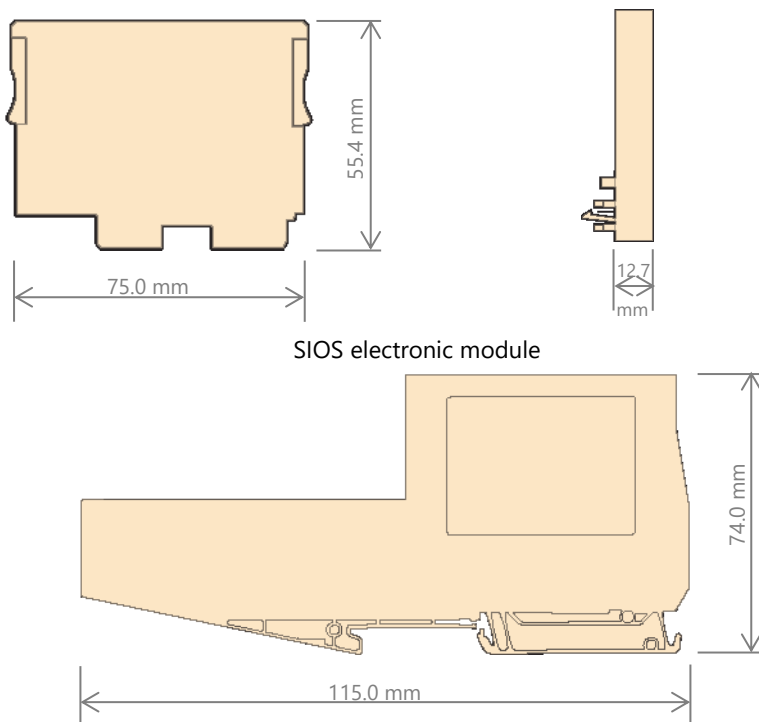

Figure 18; SIOS connection module IW1-XL



SIOS electronic module

Figure 19; Side view of gateway with electronic module

### Note on switch cabinet installation :

The following dimensions must be observed when installing SIOS nodes in the control cabinet. The width of a SIOS node with 64 modules (full configuration) is 874 mm and is calculated as follows:

Gateway + (number of modules x module width) + end protection module  
51 mm + (64 x 12.7 mm) + 10 mm

The height of a SIOS node depends on the modules used and is 154 mm when using a SIOS-IW1- XL module and 128 mm for all other modules. In addition to the actual SIOS node, an earthing bar is also required for analog signals.

## **4.3 Addressing**

---

### **4.3.1 Internal addressing of the SIOS modules**

---

The internal addressing of the individual digital and analog modules is carried out automatically for each SIOS node. The first channel of a module type (digital inputs, digital outputs, analog inputs, analog outputs) after the gateway is assigned the address 1. The subsequent channels are numbered consecutively.

Example:

Actual value 1 is assigned to the first channel of the first IW module after the gateway. If the IW module is an IW2 module, actual value 2 is assigned to the second channel. Actual value 3 is then assigned to the first channel of the second IW module, and so on. If there is an unknown number of other modules between the first and second IW module, this does not affect the assignment of the actual values. The same applies to all other module types, i.e. analog outputs, digital inputs and digital outputs.

### **4.3.2 Global addressing**

---

The global addressing in the CoDeSys project can be individually defined by the project engineer using the function blocks of the STANGE library. Further details on this topic can be found in the document SE-6xx\_STANGE\_CoDeSys\_Bibliothek-D.pdf.



## 5 Assembly

SIOS is an IO system designed for standard rail mounting.

The following pages describe the mechanical assembly of the individual SIOS components:

### 5.1 Mounting a SIOS node

The gateway, together with the power module, is placed at the bottom of the rail and the spring at the top is operated with a screwdriver. The housing snaps into place and can be moved along the rail.

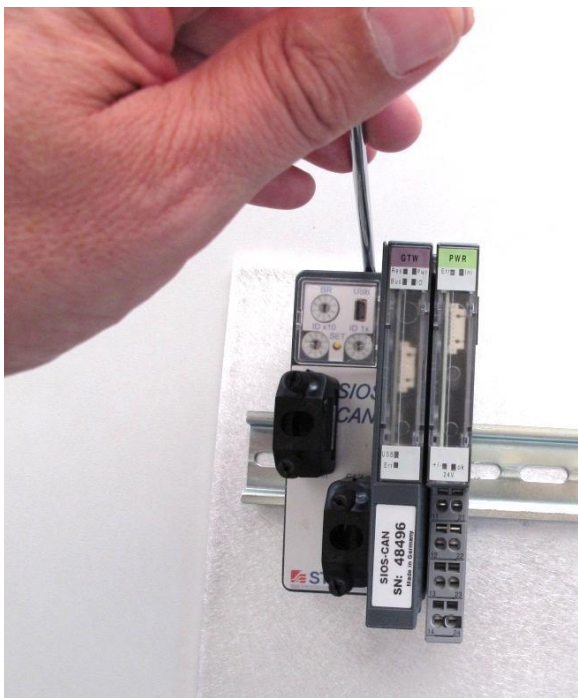

The other modules can be clicked onto the rail without tools and pushed flush against the already mounted modules. Two catches ensure that the modules are held together securely.

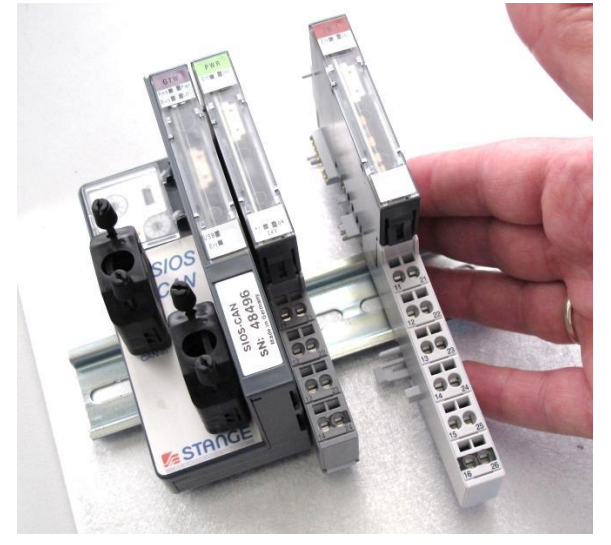
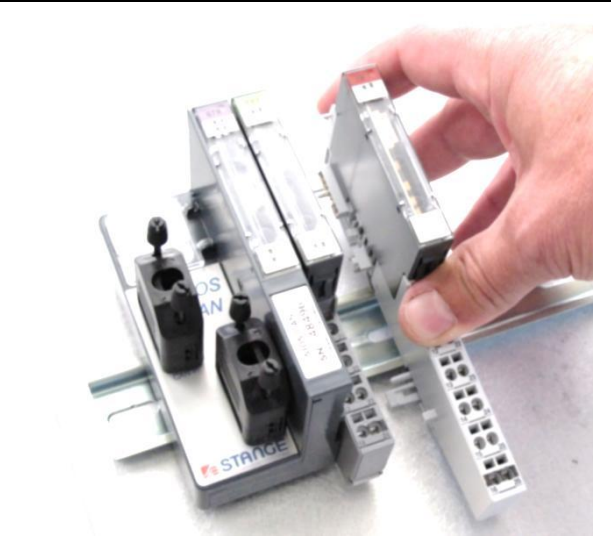

Once all modules have been placed, the terminating resistor must be attached to the last unit.

When installing, make sure that the resistor points upwards (towards the modules)!

The terminating resistor is supplied with the gateway together with the terminating plate.

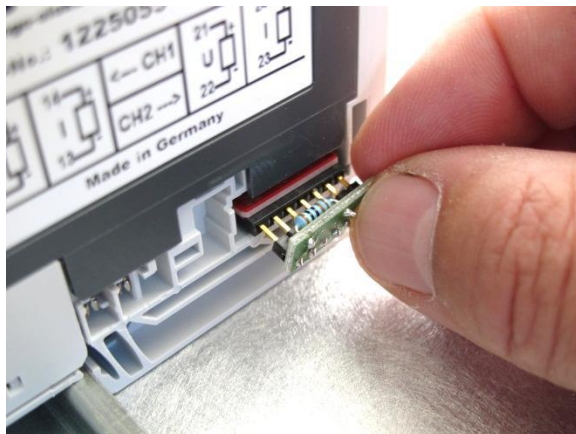

The end plate covers the open contacts and ...

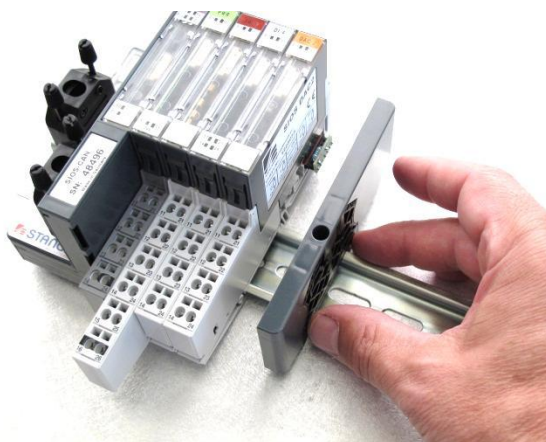

... fixes the system  
to the standard rail.

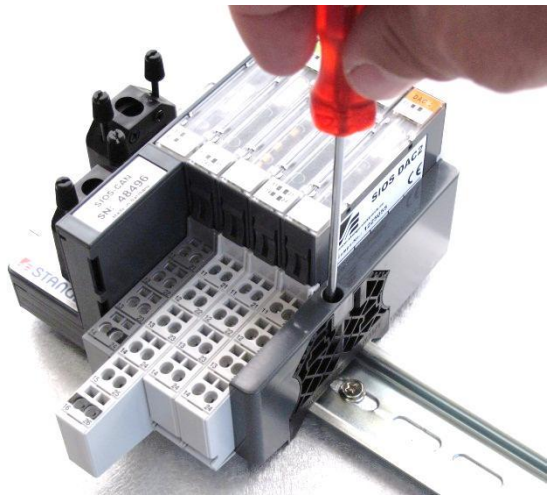

## 5.2 Shield connection for analog signals

The analog signals should be connected to the system using shielded cables. The best way to connect the shield to PE is shown in the picture on the right.

The standard rail (1) for SIOS mounting is mounted on the mounting surface in such a way that there is good electrical contact between the two components. An earthing bar (2) is fitted in front of the SIOS connection panel so that it also has good electrical contact with the mounting surface.

The braided shield is exposed in the area of the earthing busbar and reliably contacted with appropriate clamping springs.

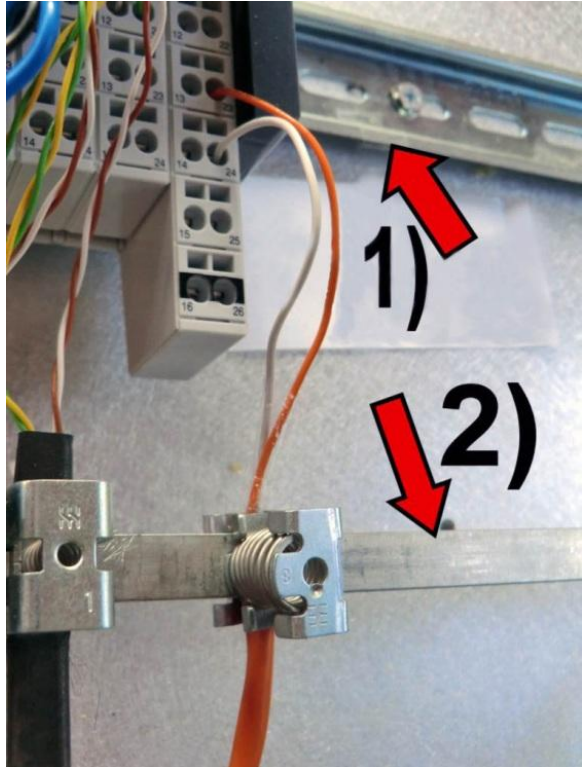

The picture on the right clearly shows the full contact of the braided shield.

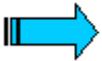
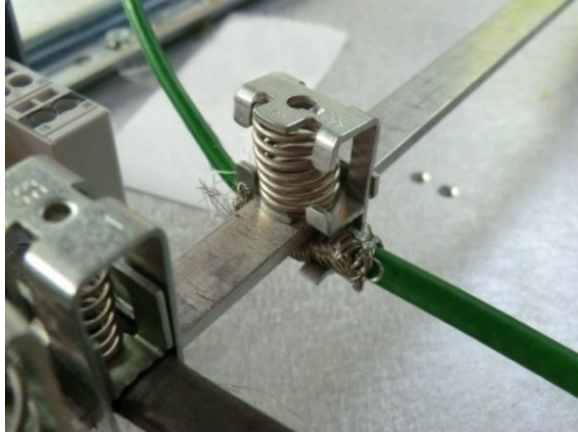

**Please  
note!**

**Ensure that the earthing rail for the shield connection and the standard rail have the same reference. If the mounting surface consists of several segments, both components should be mounted on the same segment.**

Only use **insulated and shielded** cables.

The screen **can only** be placed on **one side** in the vicinity of SIOS.

If high currents are to be expected in the system, it makes sense to use twisted cables to reduce the magnetic influences.

When connecting thermocouples , the corresponding thermocouple compensation cable must be used!

## 5.3 Replacement of modules

The modules are "hot plug" capable. In the event of a fault, they can therefore be replaced with an intact module of the same type during operation.

By pressing in the two catches (see illustration), the lock is released and the module can be removed.

The new module is simply plugged in. Make sure that both latches click into place.

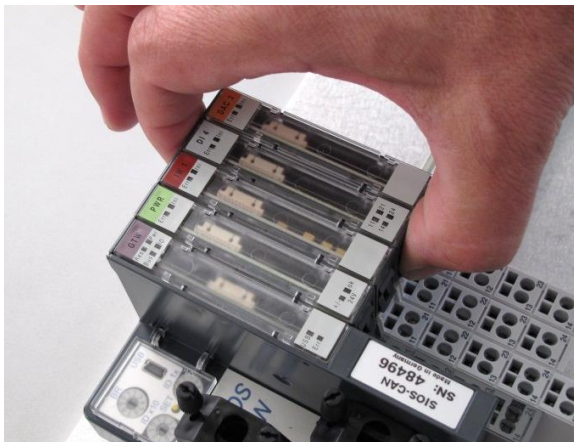

If one or more modules are removed, coding (see markings in the image) prevents an incorrect module type from being plugged into the free space.

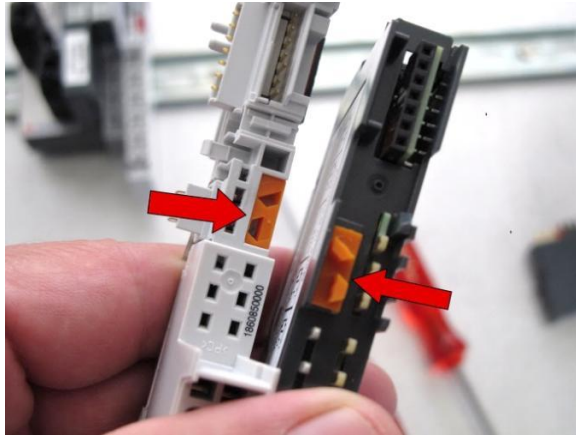

The coloring of the coding is identical to the colors in the type designation in the labeling field of the module.

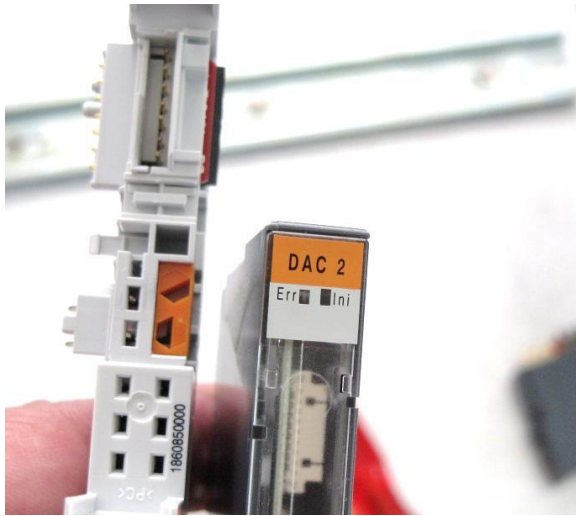



## 5.4 Dismantling the modules

It's not supposed to happen, but it does. A module support has to be replaced because it is defective or another one has to be installed in the middle of the row.

Using a wide, flat screwdriver, go between the two modules that are to be separated and carefully push it into the gap until the tip is in the area of the module. You will notice that the gap widens and the carriers are separated.

As the supports are moved on the standard rail during this process, it is essential to ensure that a maximum of 2 - 3 modules can be moved on the rail. If you try to move 5 or more supports at the same time, the force required is so great that there is a risk of damage.

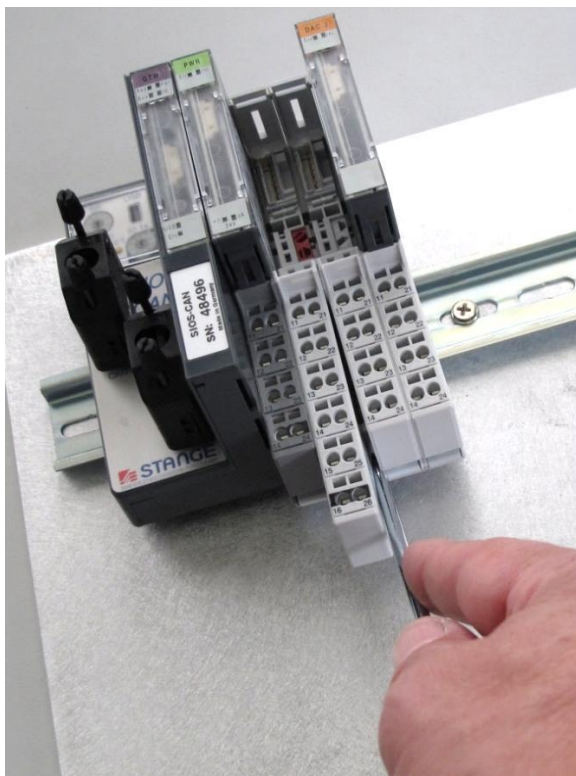

An individual module support is released from the standard rail by unlocking the catch spring on the back using a suitable screwdriver. At the same time, the carrier can be removed from the rail.

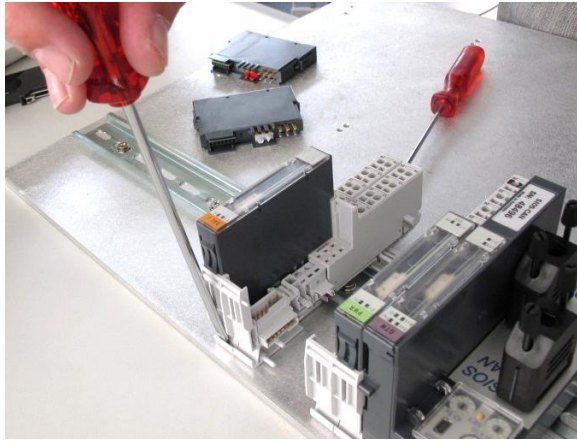

## 5.5 The structure of the module

To 1)  
The internal bus establishes communication with the gateway and supplies the operating voltage (5V) to the modules.

Re 2)  
The supply voltage (24V) is passed from module to module via these two contacts. The capacity of these contacts is limited. Therefore, large loads (such as the SIOS-DO4) receive the supply voltage from outside.

Re 3)  
This contact is not used.

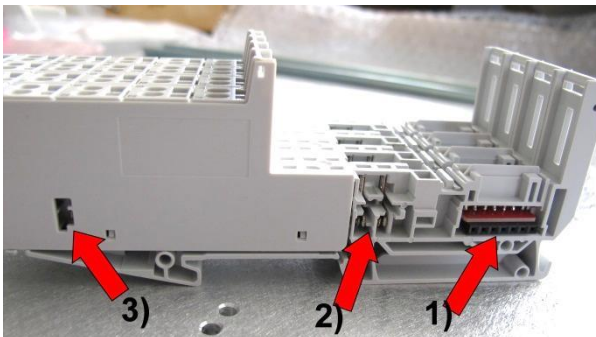

The two catches  
(markings in the  
picture) must be  
released if two  
module supports  
are to be detached  
from each other.

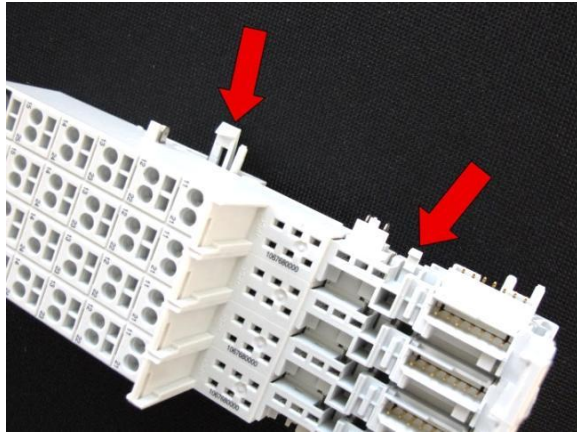

## 5.6 Save module list (SET button)

Once the SIOS node has been fitted and installed as planned, the module constellation of the SIOS node still needs to be saved in the gateway. To do this, the small SET button between the ID rotary switches of the gateway must be held down during the switch-on process. The SET button may only be released again when the IO-LED of the gateway signals the completion of the saving process.

Procedure:

- Switch off the SIOS node, or pull out the power module
- Press and hold the yellow SET button
- Switch on the power supply to the SIOS node, or reconnect the power module
- IO LED lights up
- IO LED goes out
- IO-LED flashing t fast
- IO LED goes out
- Release the yellow SET button

The current module list has been saved internally as a new target list. If one of the modules is changed during operation, this change is detected and signaled (the IO LED flashes at 500 ms intervals).





**ATTENTION!**

If dummy modules are to be used, the desired I/O modules must be plugged in when the setpoint list is saved. The I/O modules can only be replaced by dummy modules once the target configuration has been saved. If a dummy module is plugged into a position where there is not yet a target configuration, the dummy module is displayed as a dummy module and thus saved in the target configuration. Subsequent replacement of the dummy modules with I/O modules is therefore no longer possible without reconfiguration.

When saving the module list, make sure that there are **no gaps**. The Gateway only recognizes all modules that are plugged in one after the other. If there is a gap in the system, the modules that follow are **no longer recognized**.

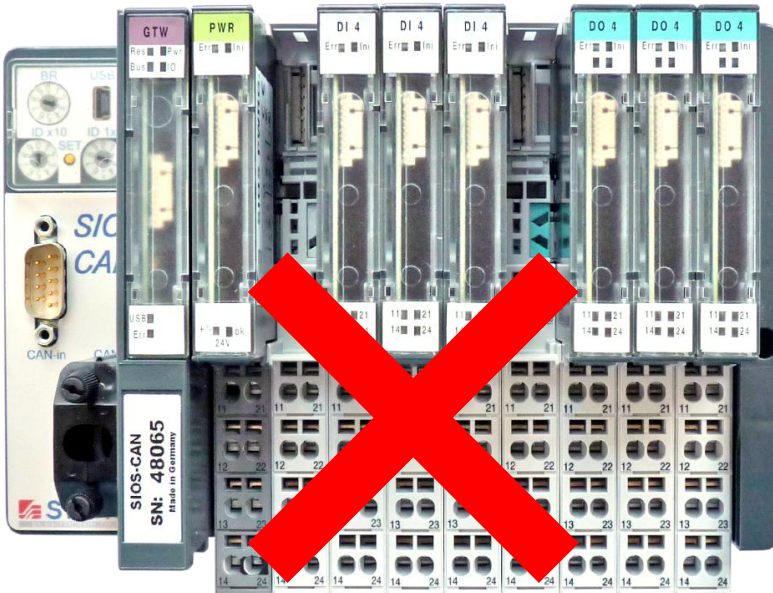

## 6 Index

---

<b>1</b>	<b>F</b>
1.2 Explanation of symbols 9	Fax 12
1.3 Liability and warranty 10	
<b>A</b>	<b>G</b>
Application example of a dummy module 49	Gateway view 16
assembly 57	General information 21
	Globale addressing 56
<b>B</b>	<b>H</b>
Baud rate rotary switch 19	Hardware concept 15
BETRIEBSSICHERHEIT 5	Homepage 12
bus address 17	
<b>C</b>	<b>I</b>
CAN 17	Intended use 11
CAN termination 22, 25	Internal addressing 56
connection 17	
Connection technology 13	<b>L</b>
<b>D</b>	LED information 22
dimensions 13	<b>M</b>
Dimensions 54	Manufacturer's address 12
Dismantling modules 65	
<b>E</b>	<b>N</b>
EG-KONFORMITÄTSERKLÄRUNG 4	Node-ID rotary switch 17
E-Mail 12	<b>P</b>
	Phone 12

PIN assignment 24  
Potentiometer 41  
Power consumption 13  
Project planning 53  
protection class 13  
PT100/ PT1000 4-Wire 40  
PT100/PT1000 3-wire 39

## **R**

Repairs 12  
replacement of modules 63

## **S**

save module list 69  
SET button 69  
Shield connection 61  
Shielding of I/O wires 5  
simulate a programmed target  
module 48  
SIOS DAC2 45  
SIOS DI4 29  
SIOS DO4 32  
SIOS Dummy 48

SIOS IW1 35  
SIOS IW2 42  
SIOS PWR (G) 26  
SIOS-CAN Gateway 22  
structure of modules 67  
Supply voltage 13  
Support 12  
Support phone 12  
Support-E-Mail 12  
switch cabinet installation 55  
System concept 14

## **T**

Technical data 13  
Technical support 12  
Temperature range 13  
Terminating resistor 50  
Termination protection module 50  
thermocouple 38  
Thermocouple 62  
thermocouple compensation cable  
62  
transmission rate 20  
Transportation 12



## 7 Directories

---

FIGURE 1; GATEWAY	16
FIGURE 2; BAUD RATE ROTARY SWITCH	19
FIGURE 3; SIOS-CAN GATEWAY	22
FIGURE 4; CAN CABLE SE DEVICE -<> SIOS GATEWAY	24
FIGURE 5; CAN CABLE SIOS - <> SIOS	25
FIGURE 6; TERMINATING PLUG PIN ASSIGNMENT	25
FIGURE 7; SIOS MODULE	26
FIGURE 8; PWR MODULE PIN ASSIGNMENT	28
FIGURE 9; DI4 MODULE PIN ASSIGNMENT	31
FIGURE 10; DO4 MODULE PIN ASSIGNMENT	34
FIGURE 11; IW1-XL MODULE CONNECTION ASSIGNMENT	38
FIGURE 12; IW1-XL MODULE TERMINAL ASSIGNMENT PT 3-WIRE	39
FIGURE 13; IW1-XL MODULE PIN ASSIGNMENT PT 4-WIRE	40
FIGURE 14; IW1-XL MODULE POTENTIOMETER CONNECTION ASSIGNMENT	41
FIGURE 15; PIN ASSIGNMENT IW2- MODULE	44
FIGURE 16; DAC2 MODULE CONNECTION ASSIGNMENT	47
FIGURE 17; SIOS CONNECTION MODULE	54
FIGURE 18; SIOS CONNECTION MODULE IW1-XL	54
FIGURE 19; SIDE VIEW OF GATEWAY WITH ELECTRONIC MODULE	55
TABLE 1 ; TECHNICAL DATA	13
TABLE 2; LIST OF THE DIFFERENT MODULE TYPES	15
TABLE 3; GATEWAY CAN CONNECTION	17
TABLE 4; BAUD RATE SETTINGS	20
TABLE 5; LED INFORMATION	22
TABLE 6; PWR MODULE LED MESSAGES	27
TABLE 7; LED MESSAGES DI4 MODULE	30
TABLE 8; LED MESSAGES DO4 MODULE	33
TABLE 9; LED MESSAGES IW1-XL MODULE	36
TABLE 10; IW1 MODULE ERROR RANGES	38
TABLE 11; LED MESSAGES IW2 MODULE	43
TABLE 12; IW-2 MODULE ERROR AREAS	44
TABLE 13; LED MESSAGES DAC2 MODULE	46
TABLE 14; LED MESSAGES DUMMY MODULE	48